



**DESCRIPTION**

The AX3 Series is a versatile set of arrayable, full-range modules that can provide the "horsepower" for the high outputs required in larger venues. The AX3 Series include horn patterns from 45° x 45° to 90° x 60°. All AX enclosures, including the AX2 Series and companion AX122 subwoofer, have an identically sized, dual trapezoidal shape. This permits creating horizontally or vertically orientated arrays in a variety of beamwidths, with the AX's superior horizontal and vertical pattern symmetry maintaining the proper relationship between the polar patterns. A set of 3/8-16 threaded mounting points facilitate installation.

Single-amp and bi-amp operating modes are user-selectable. In single-amp mode, the passive crossover is designed to work with a digital signal processor (DSP). This reduces the crossover's complexity, minimizes power losses, and provides more sophisticated digital processing to maximize performance.

The AX3 Series features a newly-designed, coaxial transducer with high efficiency, MF cone and HF compression drivers. The drivers share a common, neodymium magnet allowing closely spaced voice coils. This minimizes the distance between the MF and HF acoustic origins for highly coherent sound both on and off axis. The MF's sealed, aluminum chassis acts as a heat sink for the entire assembly.

The MF/HF transducer loads into a large, common horn via a modified version of the EAW's patented Radial Phase Plug™. A unique HF waveguide is integrated within the center of the phase plug. It is acoustically transparent to the MF energy while being acoustically opaque to and acting as a waveguide for the HF energy.

The low frequencies are reproduced by a pair of spaced, 12-inch cone drivers. This LF subsystem maintains the overall coaxial design as its acoustic origin is along the acoustic axis of the MF/HF subsystem. In addition, the LF driver spacing provides better pattern control than systems of similar size that use a single LF driver.

The companion AX122 subwoofer is designed to extend the low frequency response of the AX3 full-range loudspeakers. With an identically-sized enclosures, AX122s array perfectly with AX3s.

Six year warranty.

**3-WAY FULL-RANGE COAXIAL, 45° x 45°**

See *NOTES TABULAR DATA* for details

**CONFIGURATION**

Subsystem		
	<i>Transducer</i>	<i>Loading</i>
LF	2x 12 in cone	Phase Aligned™
MF	1x 8 in cone	Horn-loaded w/Radial Phase Plug™
HF	1x 1.4 in exit, 2.5 in voice coil compression driver	Horn-loaded w/Radial Phase Plug™

Operating Mode		
	<i>Amplifier Channels</i>	<i>External Signal Processing</i>
Single-amp	LF/ MF/HF	DSP
Bi-amp	LF, MF/HF	DSP w/2-way filters

**PERFORMANCE <sup>1</sup>**

<b>Operating Range</b>	68 Hz to 20 kHz
<b>Nominal Beamwidth</b>	
Horz	45°
Vert	45°

<b>Axial Sensitivity (whole space SPL)</b>		
LF/MF/HF	103 dB	68 Hz to 20 kHz
LF	103 dB	68 Hz to 335 Hz
MF/HF	104 dB	275 Hz to 20 kHz

<b>Input Impedance (ohms)</b>		
	<i>Nominal</i>	<i>Minimum</i>
LF/MF/HF	8	6.4 @ 95 Hz
LF	8	7.9 @ 165 Hz
MF/HF	8	6.9 @ 3110 Hz

<b>High Pass Filter</b>	
High Pass	=>40 Hz, 24 dB/octave Butterworth

<b>Accelerated Life Test <sup>2</sup></b>		
LF/MF/HF	80 V	800 W @ 8 ohm
LF	89 V	1000 W @ 8 ohm
MF/HF	49 V	300 W @ 8 ohm

<b>Calculated Axial Output Limit (whole space SPL)</b>		
	<i>Average</i>	<i>Peak</i>
LF/MF/HF	132 dB	138 dB
LF	133 dB	139 dB
MF/HF	129 dB	135 dB

**ORDERING DATA**

<i>Description</i>	<i>Part Number</i>
AX344 3-Way Full-Range Loudspeaker Black	0010473
AX344 3-Way Full-Range Loudspeaker White	0011591
AX344 3-Way Full-Range Loudspeaker Black WP	0011577

<b>Optional Accessories</b>	
Eyebolt/Forged Shoulder (3/8-16 x 1.25 in)	104001

<sup>1</sup> To achieve specified performance, the listed external signal processing with EAW-provided settings is required.

<sup>2</sup> For recommendations to select power amplifier size refer to: "HOW MUCH AMPLIFIER POWER DO I NEED?" on the EAW web site.

## ENCLOSURE

Material	Baltic birch plywood
Finish	Wear resistant textured black paint
Grille	Powder-coated perforated steel

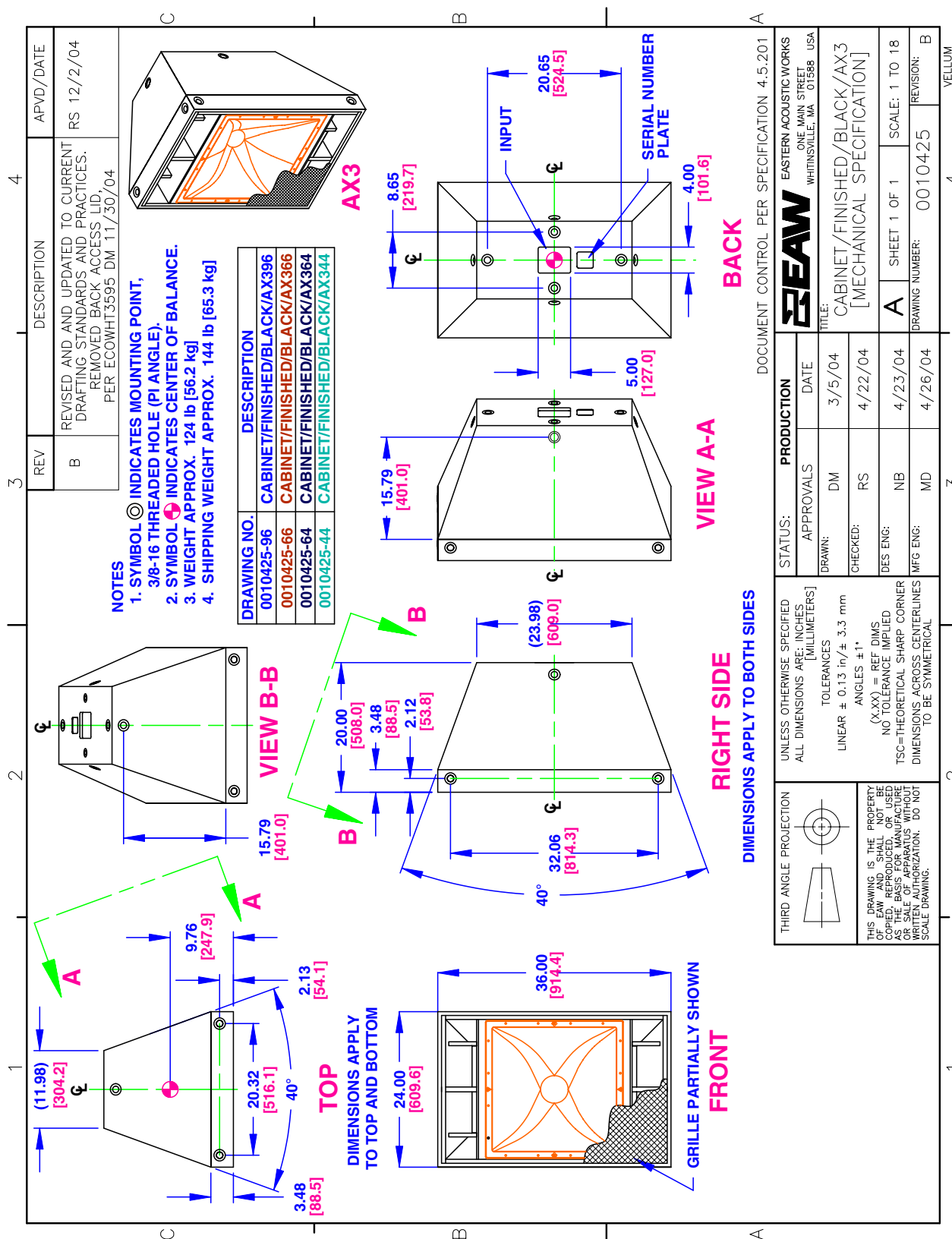

STATUS: PRODUCTION		DOCUMENT CONTROL PER SPECIFICATION 4.5.201	
APPROVALS	DATE	EASTERN ACOUSTIC WORKS ONE MAIN STREET WHITINSVILLE, MA 01588 USA	
DRAWN: DM	3/5/04	TITLE: CABINET/FINISHED/BLACK/AX3 [MECHANICAL SPECIFICATION]	
CHECKED: RS	4/22/04	A SHEET 1 OF 1 SCALE: 1 TO 18	
DES ENG: NB	4/23/04	DRAWING NUMBER: 0010425 REVISION: B	
MFG ENG: MD	4/26/04	4	

**NOTES:** This drawing has been reduced. Do not scale.  
For WP version, add 0.25 in / 6.4 mm to the outside dimensions = 0.125 in / 3.2 mm all around.



## PERFORMANCE DATA

See **NOTES GRAPHIC DATA** for details

### Frequency Response: Processed Bi-amplified

LF = green, MF/HF = black, Complete = blue

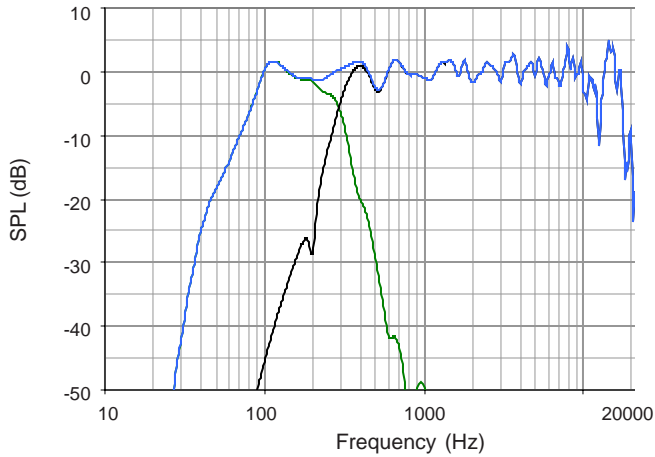

### Frequency Response: Processed Single-amplified

Complete = blue

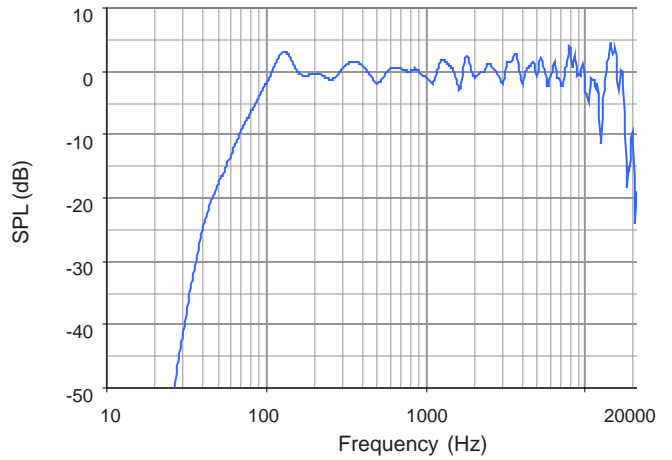

### Frequency Response: Unprocessed

LF = green, MF/HF = black, Single-amp = blue

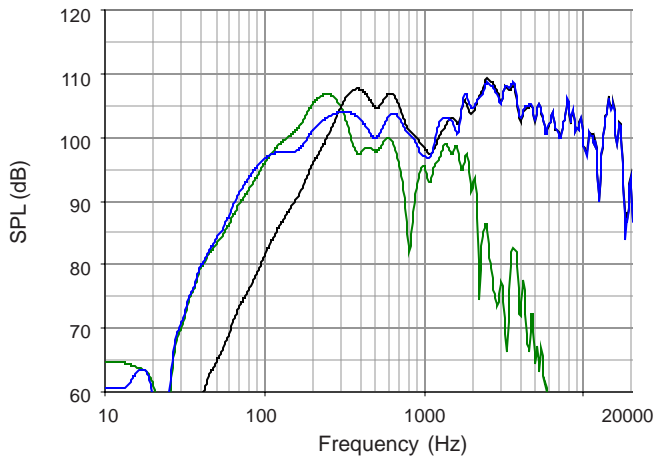

### Frequency Response: Digital Signal Processor

LF = green, MF/HF = black, Single-amp = blue

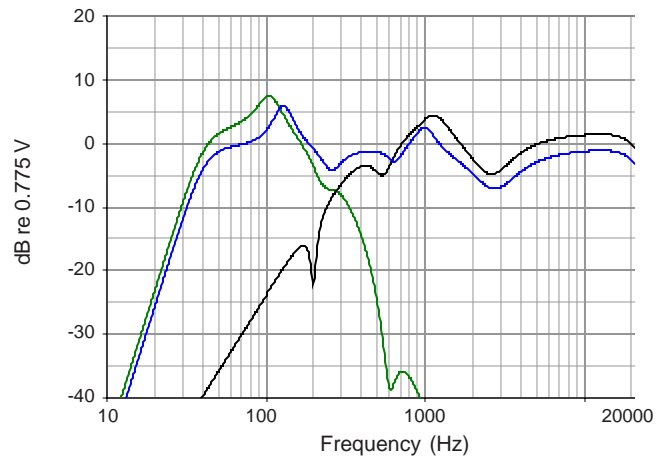

### Impedance Magnitude

LF = green, MF/HF = black, Single-amp = blue

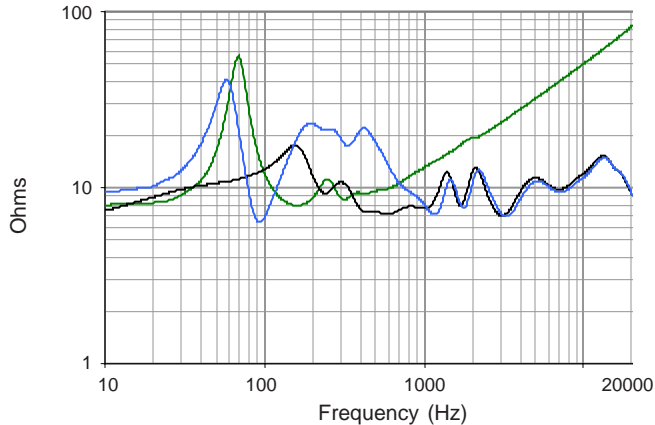

### Beamwidth (-6 dB SPL Points)

Horizontal = orange Vertical = black

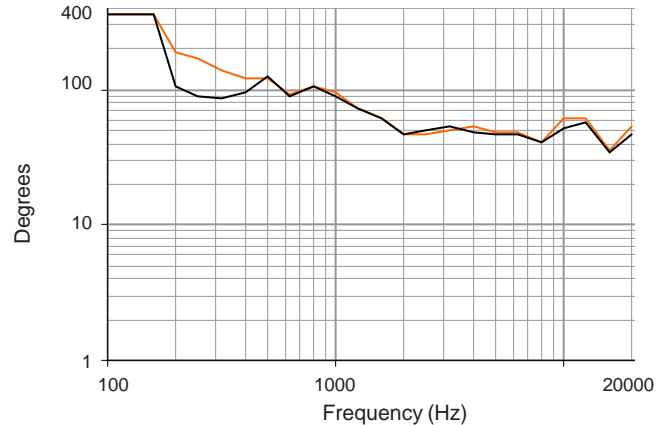

## HORIZONTAL POLAR DATA (Gridlines: 6 dB axial / 15 degree radial)

See **NOTES GRAPHIC DATA** for details

100 Hz  
125 Hz  
160 Hz  
200 Hz

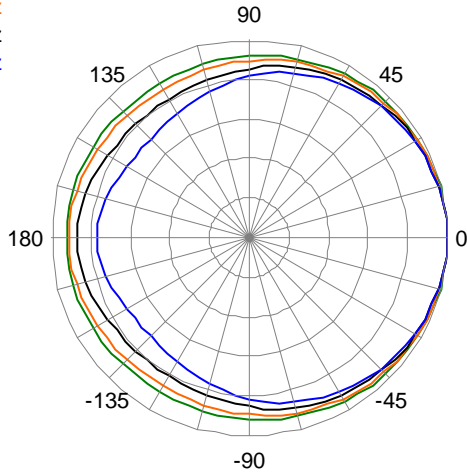

1600 Hz  
2000 Hz  
2500 Hz  
3150 Hz

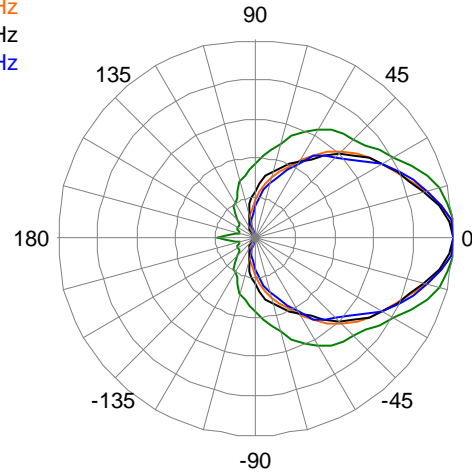

250 Hz  
315 Hz  
400 Hz  
500 Hz

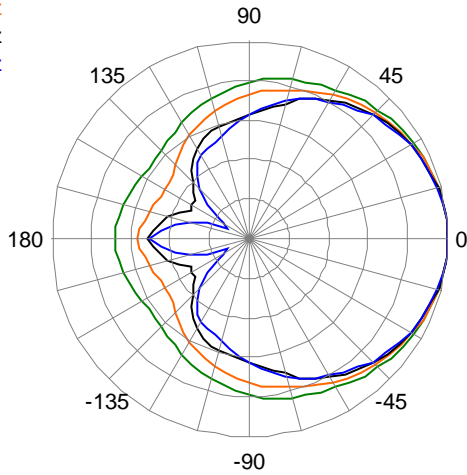

4000 Hz  
5000 Hz  
6300 Hz  
8000 Hz

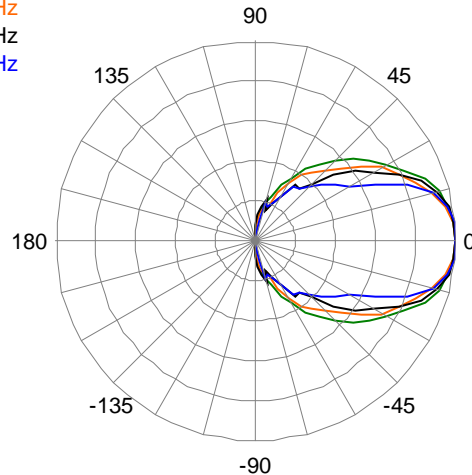

630 Hz  
800 Hz  
1000 Hz  
1250 Hz

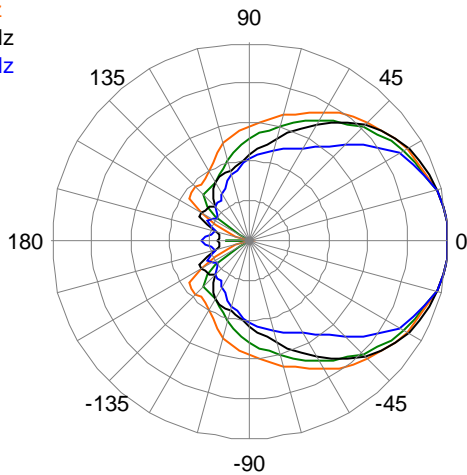

10000 Hz  
12000 Hz  
16000 Hz

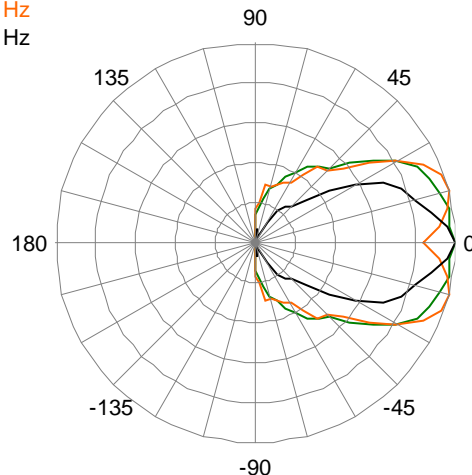

## VERTICAL POLAR DATA (Gridlines: 6 dB axial / 15 degree radial)

See **NOTES GRAPHIC DATA** for details

100 Hz  
125 Hz  
160 Hz  
200 Hz

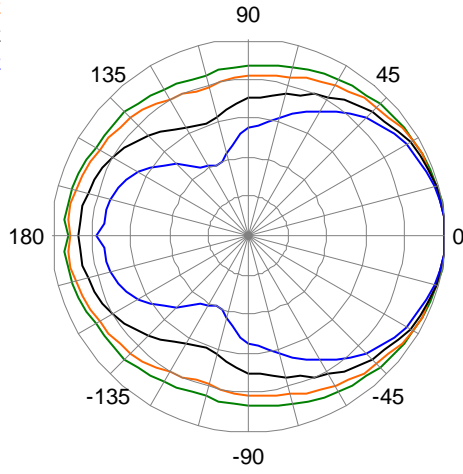

1600 Hz  
2000 Hz  
2500 Hz  
3150 Hz

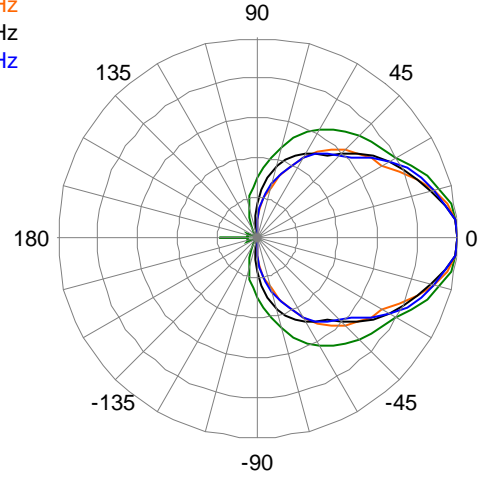

250 Hz  
315 Hz  
400 Hz  
500 Hz

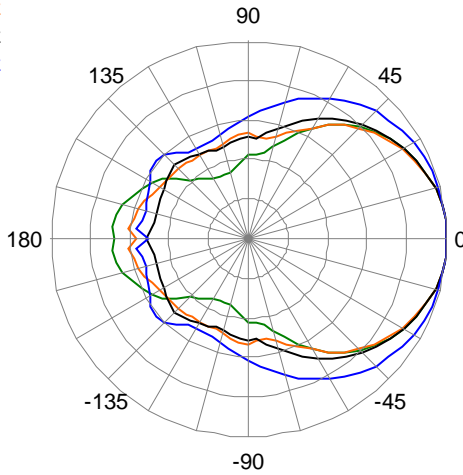

4000 Hz  
5000 Hz  
6300 Hz  
8000 Hz

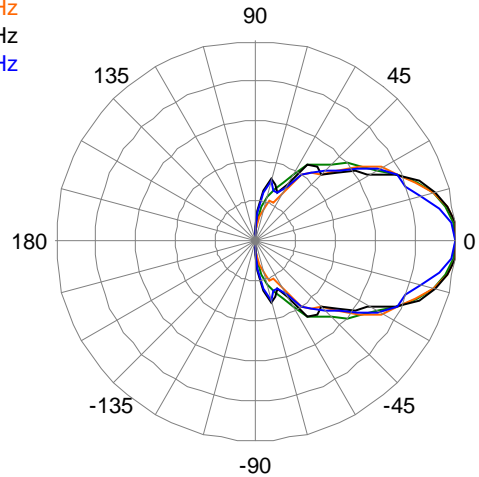

630 Hz  
800 Hz  
1000 Hz  
1250 Hz

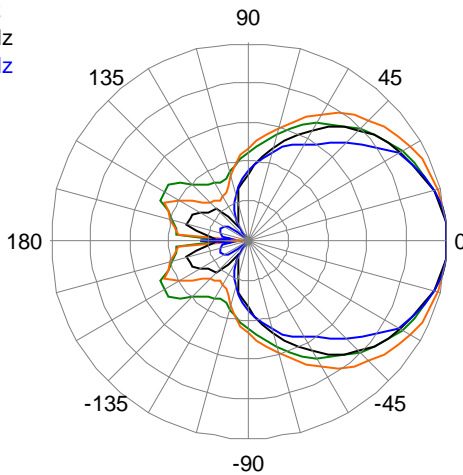

10000 Hz  
12000 Hz  
16000 Hz

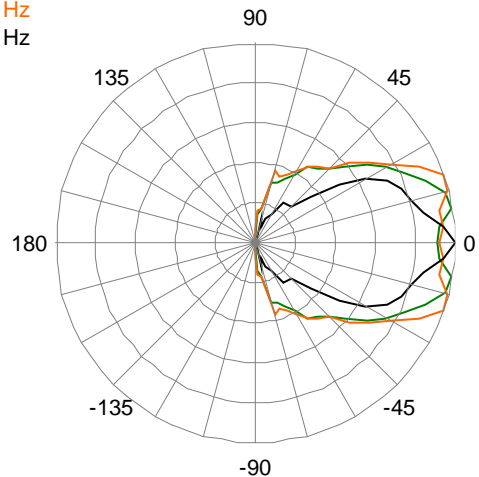

## INPUT PANEL

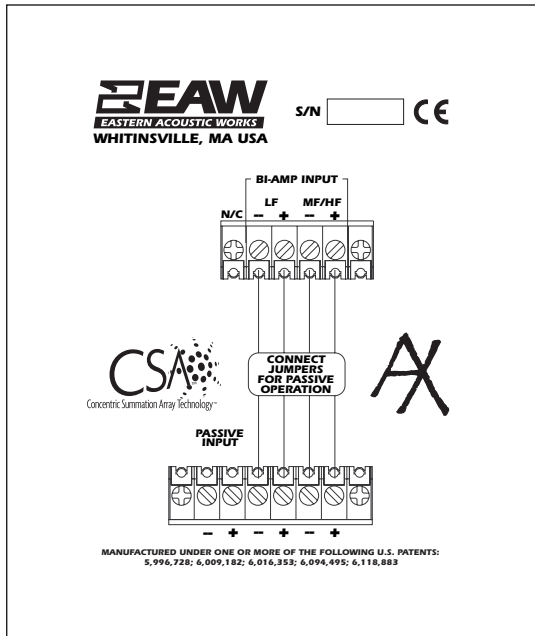

## SIGNAL DIAGRAM

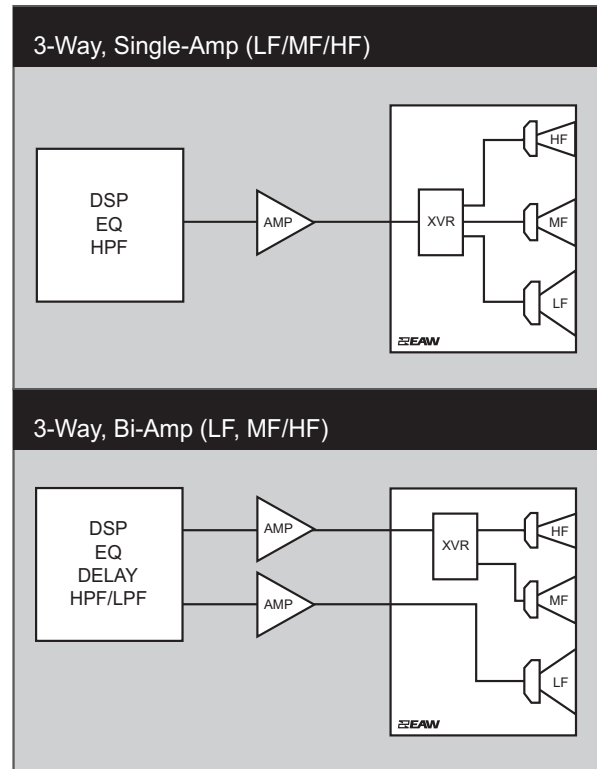

## HORN PATTERN LABEL (factory installed horn orientation)

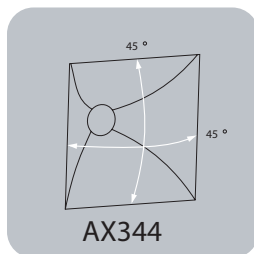

## LEGEND

- DSP:** User-supplied Digital Signal Processor.
- HPF:** High Pass Filter for crossover or Recommended High Pass Filter.
- LPF:** Low Pass Filter for crossover.
- LF/MF/HF:** Low Frequency / Mid Frequency / High Frequency.
- AMP:** User-supplied Power Amplifier.
- XVR:** Passive LPFs, HPFs, and EQ integral to the loudspeaker.

## NOTES

### TABULAR DATA

1. **Measurement/Data Processing Systems:** Primary - FChart: proprietary EAW software; Secondary - Brüel & Kjær 2012.
2. **Microphone Systems:** Earthworks M30; Brüel & Kjær 4133
3. **Measurements:** Dual channel FFT; length: 32 768 samples; sample rate: 48 kHz; logarithmic sine wave sweep.
4. **Measurement System Qualification** (includes all uncertainties): SPL: accuracy +/-0.2 dB @ 1 kHz, precision +/-0.5 dB 20 Hz to 20 kHz, resolution 0.05 dB; Frequency: accuracy +/-1 %, precision +/-0.1 Hz, resolution the larger of 1.5 Hz or 1/48 octave; Time: accuracy +/-10.4 µs, precision +/-0.5 µs, resolution 10.4 µs; Angular: accuracy +/-1°, precision +/-0.5°, resolution 0.5°.
5. **Environment:** Measurements time-widowed and processed to eliminate room effects, approximating an anechoic environment. Data processed as anechoic or fractional space, as noted.
6. **Measurement Distance:** 7.46 m. Acoustic responses represent complex summation of the subsystems at 20 m. SPL is referenced to other distances using the Inverse Square Law.
7. **Volts:** Measured rms value of the test signal.
8. **Watts:** Per audio industry practice, "loudspeaker watts" are calculated as voltage squared divided by rated nominal impedance. Thus, these are not True Watt units of energy as defined by International Standard.
9. **SPL:** (Sound Pressure Level) Equivalent to the average level of a signal referenced to 0 dB SPL = 20 microPascals.
10. **Subsystem:** This lists the transducer(s) and their acoustic loading for each passband. Sub = Subwoofer, LF = Low Frequency, MF = Mid Frequency, HF = High Frequency.
11. **Operating Mode:** User selectable configurations. Between system elements, a comma (,) = separate amplifier channels; a slash (/) = single amplifier channel. DSP = Digital Signal Processor. IMPORTANT: To achieve the specified performance, the listed external signal processing must be used with EAW-provided settings.
12. **Operating Range:** Range where the processed Frequency Response stays within -10 dB SPL of the power averaged SPL within this range; measured on the geometric axis. Narrow band dips are excepted.
13. **Nominal Beamwidth:** Design angle for the -6 dB SPL points, referenced to 0 dB SPL as the highest level.
14. **Axial Sensitivity:** Power averaged SPL over the Operating Range with an input voltage that would produce 1 W at the nominal impedance; measured with no external processing on the geometric axis, referenced to 1 m.
15. **Nominal Impedance:** Selected 4, 8, or 16 ohm resistance such that the minimum impedance point is no more than 20% below this resistance over the Operating Range.
16. **Accelerated Life Test:** Maximum test input voltage applied with an EIA-426B defined spectrum; measured with recommended signal processing and Recommended Protection Filter.
17. **Calculated Axial Output Limit:** Highest average and peak SPLs possible during the Accelerated Life Test. The Peak SPL represents the 2:1 (6 dB) crest factor of the Life Test signal.
18. **High Pass Filter:** This helps protect the loudspeaker from excessive input signal levels at frequencies below the Operating Range.

### GRAPHIC DATA

1. **Resolution:** To remove insignificant fine details, 1/12 octave cepstral smoothing was applied to acoustic frequency responses and 1/3 octave cepstral smoothing was applied to the beamwidth and impedance data. Other graphs are plotted using raw data.
2. **Frequency Responses:** Variation in acoustic output level with frequency for a constant input signal. Processed: normalized to 0 dB SPL. Unprocessed inputs: 2 V (4 ohm nominal impedance), 2.83 V (8 ohm nominal impedance), or 4 V (16 ohm nominal impedance) referenced to a distance of 1 m.
3. **Processor Response:** The variation in output level with frequency for a constant input signal of 0.775 V = 0 dB reference.
4. **Beamwidth:** Average angle for each 1/3 octave frequency band where, starting from the rear of the loudspeaker, the output first reaches -6 dB SPL referenced to 0 dB SPL as the highest level. This method means the output may drop below -6 dB SPL within the beamwidth angle.
5. **Impedance:** Variation in impedance magnitude, in ohms, with frequency without regard to voltage/current phase. This means the impedance values may not be used to calculate True Watts (see 9 above).
6. **Polar Data:** Horizontal and vertical polar responses for each 1/3 octave frequency band 100 Hz to 16 kHz or Operating Range.

## AX SERIES TECHNOLOGY

### CONVENTIONAL LOUDSPEAKERS

Good arrayability depends on the beamwidth patterns as well as the off-axis response to be symmetrical for both the horizontal and vertical planes. A typical, high power, loudspeaker baffle is shown in Fig 1. For this and similar arrangements, the height or width of each horn is typically smaller than ideal, reducing pattern control at the low end of their passbands in one plane. Because the driver arrangement is asymmetrical, the projection pattern will be asymmetrical left-to-right and up-to-down. In addition, the physical spacing between drivers means the time arrival from each driver changes with listener location. While signal delays can correct for time arrival differences, the optimum delays can only be set for one direction. Listeners off-axis of this path will still experience different arrival times from the various drivers. When multiple loudspeakers are arrayed, these problems are compounded by the drivers in the additional loudspeakers. Better layouts, such as found in EAW's KF730, KF600, KF750, KF760, and KF850 Series have improved on some of these issues, but not all of them at one time.

To eliminate arrival time differences, provide smooth off-axis response, and optimize pattern control for arraying, drivers must be positioned symmetrically with as little physical offset as possible in all three planes. Additionally, horns need to be symmetrically sized and as large as possible to achieve the desired pattern control at their lowest frequencies.

### COAXIAL DRIVERS

A solution for the above problems is the co-axial driver, where two passbands, typically an LF (low frequency) or MF (mid frequency) cone driver and HF (high frequency) compression driver are combined within a single driver assembly. A passage is created in the center, i.e. the pole piece, of the cone driver through which the HF driver's energy passes. While this can almost eliminate any time arrival differences from the drivers, there are significant limitations to typical co-axial designs.

Horn-loading is normally required for high output loudspeakers. To this end, the cone driver's diaphragm is used as the HF horn. However, this allows the HF to be modulated by high cone excursions. In addition, a horn's rate of expansion (curvature angle) should always increase towards the horn mouth. Simply loading a coaxial driver onto a horn breaks this rule by creating a decrease in expansion rate at the driver-to-horn throat junction as shown in Fig 2. This causes significant reflections off the horn walls, with resulting multiple arrivals at the listener, and prominent, undesirable side lobes. Also, the path length from the cone center to the horn throat is longer than that from the circumference. In the crossover region, this difference is typically an appreciable fraction of a wavelength. All these things result in uneven frequency response, smeared transients, and poor pattern control.

### (CSA) CONCENTRIC SUMMATION ARRAY TECHNOLOGY

To solve these problems, EAW Engineers developed a new, sealed, coaxial driver. Its MF cone and HF compression drivers share a single magnet structure, bringing the MF and HF sources as close together as physically possible. This produces an Acoustic Singularity, essentially a point source, over the MF/HF operating range of 275 Hz to 20 kHz.

The real challenge was coupling this MF/HF device to a single horn without the acoustical difficulties of typical coaxial drivers. This required creating both an always-increasing horn expansion rate over the HF range (Fig 3) and a phase plug to properly load the MF cone driver, both to improve its efficiency and eliminate cone-to-horn path length differences. The solution involved a modified version of EAW's patented Radial Phase Plug design, developed especially for cone drivers. The phase plug was modified both to accommodate the AX's smaller MF driver diaphragm and to allow a conical HF waveguide to nest within its center, optimized for proper HF wavefront expansion into the horn (Fig 4). While a physically elegant solution, the waveguide's location within the MF phase plug meant it had to be acoustically transparent to MF energy and opaque to HF energy.

A series of holes was added to the waveguide that met both acoustical criteria. The location and sizing of these holes was based on a numerical sequence called The Fibonacci Numbers, first identified by mathematician Leonardo Fibonacci. The holes were laid out along the walls of the waveguide by crisscrossing spirals based on the sequence. The holes allow the waveguide to act as two mechanical filters: a low pass for the MF and a high pass for the HF. This behavior was used to refine the hole shapes, sizes, and quantities, the goal being raw MF and HF responses that could be easily smoothed by simple passive filters and digital signal processing (DSP). The open area of the waveguide was evenly distributed along the walls to achieve symmetrical off-axis MF response. At the same time, the hole shapes and sizes were randomized to randomize the minor HF nulls caused by the holes. This resulted in any cross section through the waveguide being physically 20% open and 80% solid (Fig 5).

### AX SERIES APPLICATION

To give array designers the most flexible, predictable and accurate array modules ever, this patent-pending, CSA device was coupled to a selection of high-Q and medium-Q horns. Closely coupled, dual 12-inch woofers located on opposite edges of the horn extends the Acoustical Singularity concept into the low frequencies. Both the MF/HF horns and dual-trapezoidal enclosures are symmetrical. This means that both the horns and enclosures are fully rotatable to create the desired array pattern.

### EAW patents for the fundamental ideas behind the AX Series:

#### 1996 US Patent 6,118,883 LF spacing to match beamwidth through crossover within a horn:

**The goal:** Consistent power response across LF to MF sub-system transitions.

**The solution:** A precise formula to calculate the LF driver spacing required by a given MF horn mouth size.

#### 1996 US Patent 6,094,495 Radial Phase Plug:

**The goal:** a midrange driver that could couple to a horn without multiple path lengths, multiple arrivals, or frequency response anomalies.

**The solution:** A cone driver with a small-radius dust cap coupled to a Radial Phase Plug that equalizes path lengths from the entire driver surface to the horn throat.

#### 2004 Patent Pending CSA Technology:

**The goal:** a coaxial MF/HF driver that could function as an Acoustical Singularity when coupled to a horn.

**The solution:** A new sealed MF/HF driver, whose cone and compression elements share the same magnet structure, and a new phase plug with an HF waveguide that allows MF energy to pass through while properly guiding the expansion of the HF wavefront.

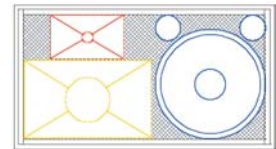

Fig 1 - Conventional High Output Loudspeaker

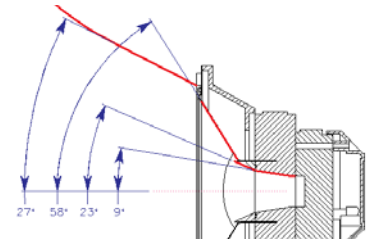

Fig 2 - Typical Coax HF Expansion

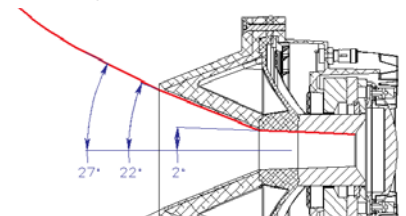

Fig 3 - AX Coax HF Expansion

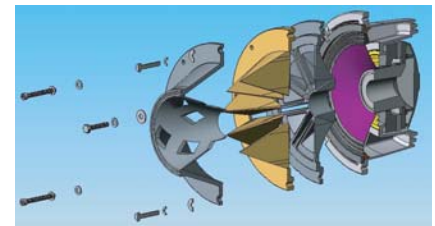
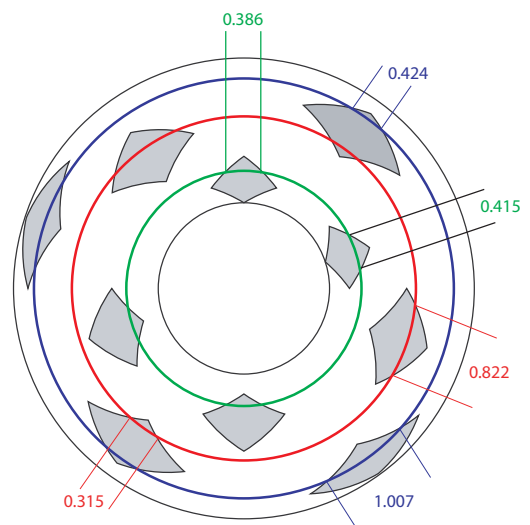

Fig 4 - AX Coaxial Driver



Green circle:  $\text{circum} = 8.017$ ,  $\text{open} = [(2 \times 0.386) + (2 \times 0.415)] / 8.017 = 20\%$   
 Red circle:  $\text{circum} = 11.728$ ,  $\text{open} = [(2 \times 0.315) + (2 \times 0.822)] / 11.728 = 20\%$   
 Blue circle:  $\text{circum} = 14.313$ ,  $\text{open} = [(2 \times 0.424) + (2 \times 1.007)] / 14.313 = 20\%$

Fig 6 - AX HF Waveguide Open Area at 3 Cross-sections